

# Kippenhok Henri

## Benodigheden:

- Schroefmachine
- Rolmaat
- Bit pz2
- Bit pz1
- Boortje 3mm (is meegeleverd)
- \*ALLE SCHROEVEN VOORBOREN\*

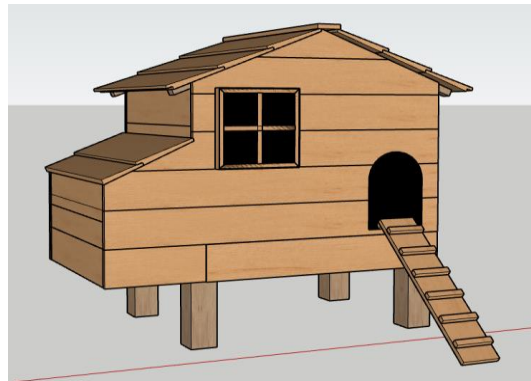

### Half houts rabat

- 8x 610mm (147x18mm)
- 1x 610mm (125x18mm)
- 1x 610mm (105x18mm)
- 1x 828mm (120x18mm)



### Schaaldelen rabat 6x 720mm



- Balk 88x88 - 4x 240mm
- Balk 38x25 - 2x 534mm
- Balk 38x25 - 2x 578mm

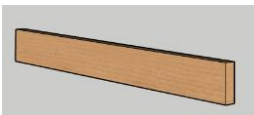

- Plank 85x16mm
- 1x 750mm



- Plank 65x16mm
- 1x 608mm

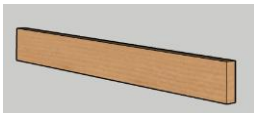

- Plank 45x16mm
- 4x 300mm

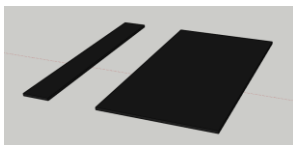

- Betonplex
- 1x 350x610mm
- 1x 110x610mm

### Voorpaneel



### Achterpaneel

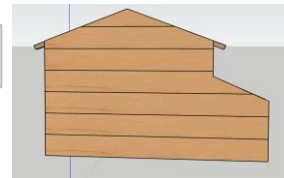

### Schuiflade



### Klep legnest



### Trapje 800mm

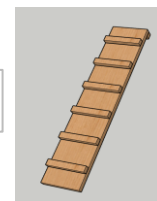

### Overige

- 34x schroef 30mm
- 89x schroef 40mm
- 2x Boortje

**1.**

**1x Achterpaneel  
1x Betonplex - 350x610mm  
3x Schroef 30mm**

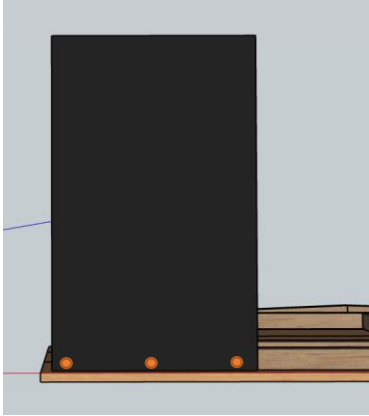

**2.**

**1x Betonplex - 110x660mm  
2x Schroef 30mm**

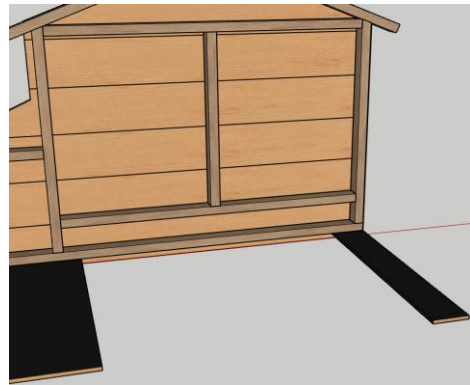
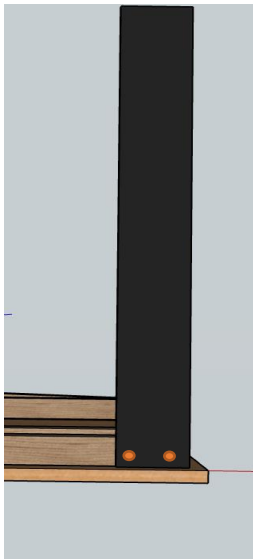

**3.**

**1x Voorpaneel  
5x Schroef 30mm**

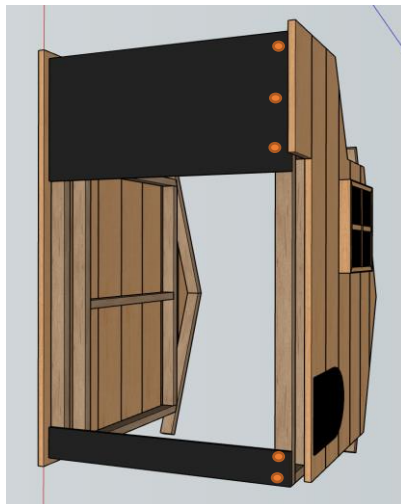

4.

1x Achterpaneel  
4x Balk 88x88 - 240mm  
12x Schroef 40mm

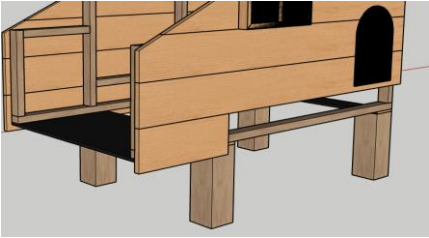
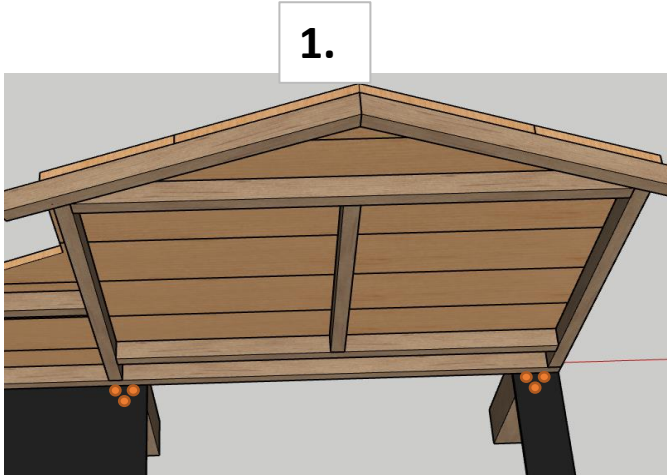

2.



5.

2x Balk 38x25 - 534mm  
8x Schroef 40mm

*Zorg dat de schroeven **niet** uit het hout steken zodat de schuiflade geen weerstand krijgt.*

1.

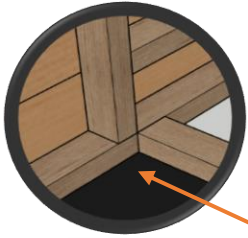
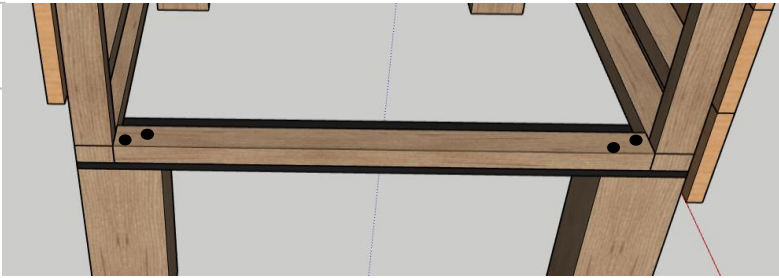

2.



6.

2x Balk 38x25 - 578mm  
4x Plank 45x16 - 300mm  
20x Schroef 30mm

1.

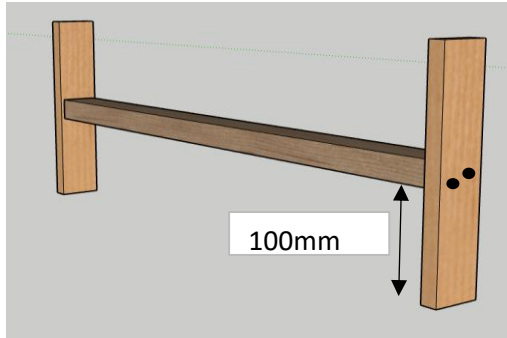

2.



7.

Linker ladegeleider  
1x Plank 65x16mm - 608mm  
4x Schroef 30mm



8.

1x Schuiflade  
1x Half houts rabat - 1x 828mm (120x18mm)  
3x Schroef 40mm



1.



2.



9.

Half houts rabat - 4x610mm (147x18mm)  
Half houts rabat - 1x610mm (125x18mm)  
20x schroef 40mm

*Verdeel de planken over de hoogte.  
Zorg dat de planken doorlopen met voor + achterzijde*

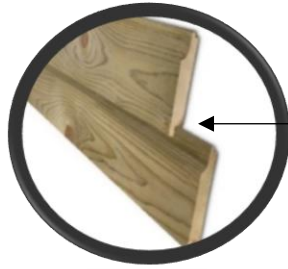
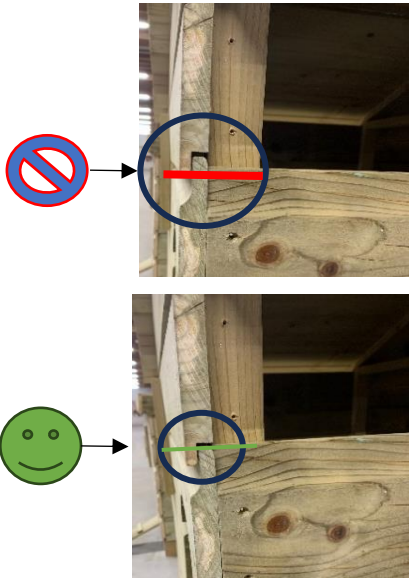

Plank 125x18mm

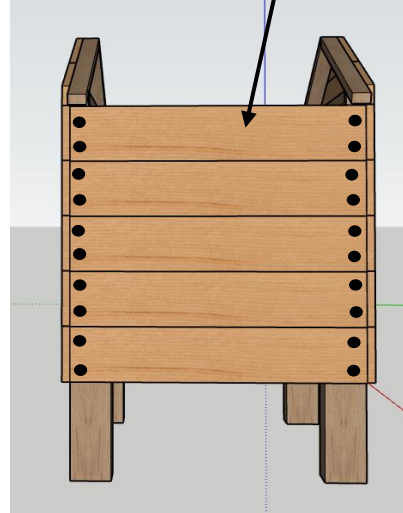

Half houts rabat - 2x610mm (147x18mm)  
8x schroef 40mm

10.

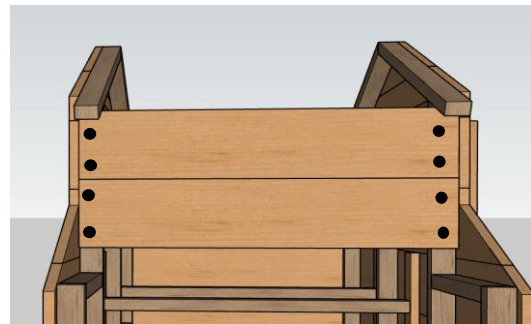
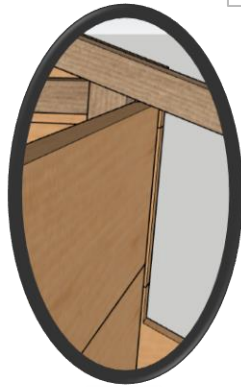

11.

Half houts rabat - 2x 610mm (147x16mm)  
Half houts rabat - 1x 610mm (105x16mm)  
12x schroef 40mm

Plank 105x18mm

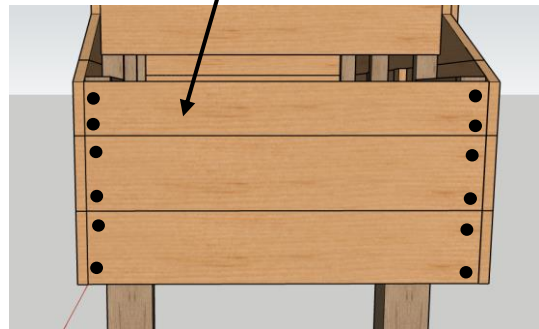

**12.**

1x Klep legnest

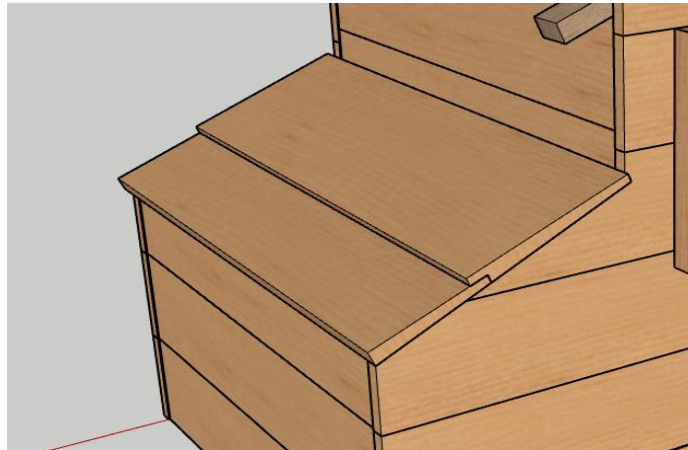

**13.**

Schaaldelen rabat - 1x 720mm  
4x schroef 40mm

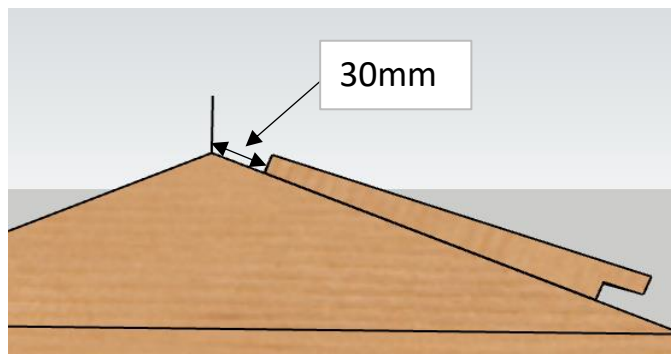
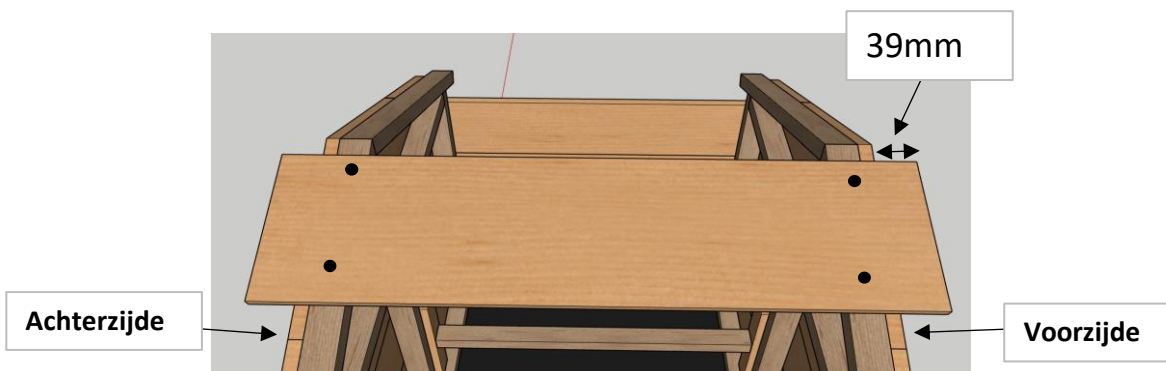

**14.**

Schaaldelen rabat - 5x 720mm  
20x schroef 40mm

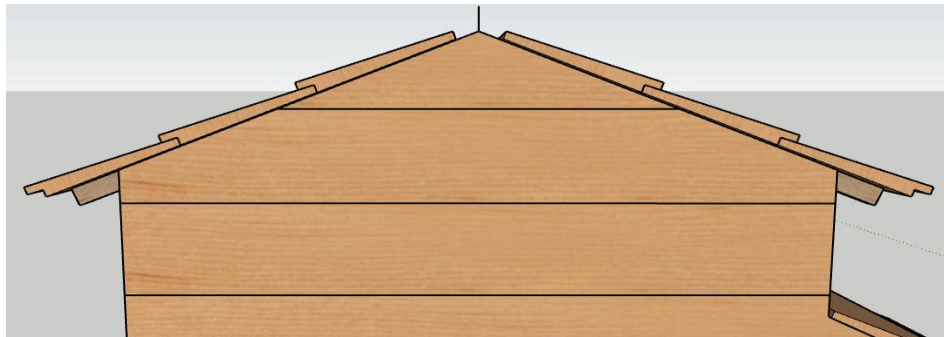
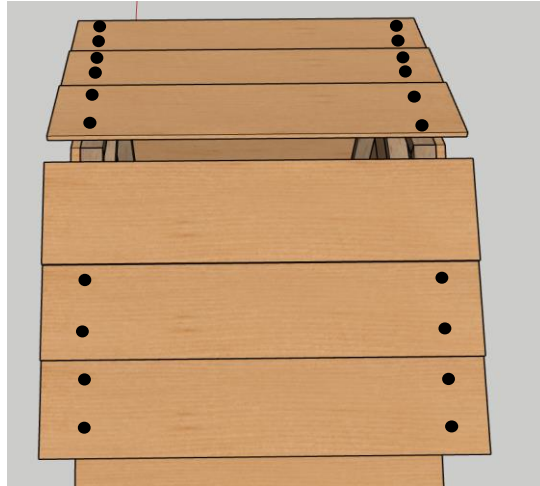

**15.**

Plank 85x16 - 1x 750mm  
2x schroef 40mm

